



# MC10N020AL

## 主要参数 MAIN CHARACTERISTICS

$I_D$	45A
$V_{DSS}$	100V
$R_{dson-max}$ (@ $V_{gs}=10V$ )	20m $\Omega$
$Q_g-typ$	30.5nC

### 用途

- 电信与工业领域隔离 DC/DC 转换
- 同步整流领域 DC/DC 与 AC/DC 转换

### 产品特性

- 低栅极电荷
- 低  $R_{dson}$
- 开关速度快
- 产品全部经过雪崩测试
- 高抗  $dv/dt$  能力
- RoHS 产品

### APPLICATIONS

- Isolated DC/DC Converters in Telecom and Industrial
- Synchronous Rectification in DC/DC and AC/DC Converters

### FEATURES

- Low gate charge
- Low  $R_{dson}$
- Fast switching
- 100% avalanche tested
- Improved  $dv/dt$  capability
- RoHS product

## 封装 Package

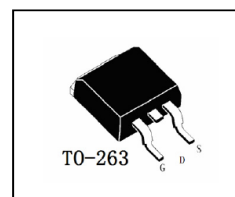
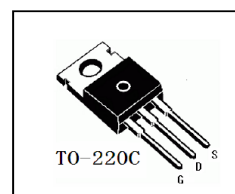
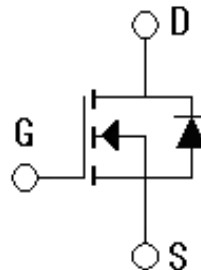

## 订货信息 ORDER MESSAGE

订货型号 Order codes				印 记 Marking	封 装 Package
有卤-条管 Halogen-Tube	无卤-条管 Halogen-Free-Tube	有卤-编带 Halogen-Reel	无卤-编带 Halogen-Free-Reel		
MC10N020AL-C-B	MC10N020AL -C-BR	N/A	N/A	MC10N020AL	TO-220C
MC10N020AL-S-B	MC10N020AL -S-BR	MC10N020AL -S-A	MC10N020AL -S-AR	MC10N020AL	TO-263



## 绝对最大额定值 ABSOLUTE RATINGS (Tc=25℃)

项 目 Parameter	符 号 Symbol	数 值 Value	单 位 Unit
		MC10N020AL	
最高漏极-源极直流电压 Drain-Source Voltage	V <sub>DSS</sub>	100	V
连续漏极电流 Drain Current -continuous	I <sub>D</sub> T=25℃	45*	A
	I <sub>D</sub> T=100℃	29*	A
最大脉冲漏极电流 (注1) Drain Current - pulse (note 1)	I <sub>DM</sub>	180*	A
最高栅源电压 Gate-Source Voltage	V <sub>GSS</sub>	±14	V
单脉冲雪崩能量 (注2) Single Pulsed Avalanche Energy (note 2)	E <sub>AS</sub>	100	mJ
雪崩电流 (注1) Avalanche Current (note 1)	I <sub>AS</sub>	20	A
耗散功率 Power Dissipation	P <sub>D</sub> T <sub>C</sub> =25℃ -Derate above 25℃	83	W
		0.67	W/℃
最高结温及存储温度 Operating and Storage Temperature Range	T <sub>J</sub> , T <sub>STG</sub>	-55~+150	℃
引线最高焊接温度 Maximum Lead Temperature for Soldering Purposes	T <sub>L</sub>	300	℃

\*漏极电流由最高结温限制

\*Drain current limited by maximum junction temperature



## 电特性 ELECTRICAL CHARACTERISTICS

项 目 Parameter	符 号 Symbol	测试条件 Tests conditions	最小 Min	典型 Typ	最大 Max	单 位 Units
<b>关态特性 Off –Characteristics</b>						
漏—源击穿电压 Drain-Source Voltage	$BV_{DSS}$	$I_D=250\mu A, V_{GS}=0V$	100	-	-	V
零栅压下漏极漏电流 Zero Gate Voltage Drain Current	$I_{DSS}$	$V_{DS}=100V, V_{GS}=0V,$ $T_C=25^\circ C$	-	-	10	$\mu A$
正向栅极体漏电流 Gate-body leakage current, forward	$I_{GSSF}$	$V_{DS}=0V, V_{GS}=11V$	-	-	100	nA
反向栅极体漏电流 Gate-body leakage current, reverse	$I_{GSSR}$	$V_{DS}=0V, V_{GS}=-11V$	-	-	-100	nA
<b>通态特性 On-Characteristics</b>						
阈值电压 Gate Threshold Voltage	$V_{GS(th)}$	$V_{DS} = V_{GS}, I_D=250\mu A$	1	2	3	V
静态导通电阻 Static Drain-Source On-Resistance	$R_{DS(ON)}$	$V_{GS}=10V, I_D=20A$	-	17.5	20	m $\Omega$
		$V_{GS}=4.5V, I_D=20A$	-	23	29	m $\Omega$
正向跨导 Forward Transconductance	$g_{fs}$	$V_{DS} = 5V, I_D=50A$ (note 4)	-	30	-	S
<b>动态特性 Dynamic Characteristics</b>						
栅电阻 Gate resistance	$R_g$	$f=1.0MHz, open\ drain$	-	2.3	-	$\Omega$
输入电容 Input capacitance	$C_{iss}$	$V_{DS}=50V,$ $V_{GS}=0V,$ $f=1.0MHz$	-	2250	-	pF
输出电容 Output capacitance	$C_{oss}$		-	170	-	pF
反向传输电容 Reverse transfer capacitance	$C_{rss}$		-	35	-	pF



## 电特性 ELECTRICAL CHARACTERISTICS

开关特性 Switching Characteristics					
延迟时间 Turn-On delay time	$t_d(\text{on})$	$V_{DD}=50V, V_{GS}=10V$ $I_D=30A, R_G=5.0\Omega$ , (note 3, 4)	-	11	- ns
上升时间 Turn-On rise time	$t_r$		-	50	- ns
延迟时间 Turn-Off delay time	$t_d(\text{off})$		-	29	- ns
下降时间 Turn-Off Fall time	$t_f$		-	75	- ns
栅极电荷总量 Total Gate Charge	$Q_g$	$V_{DS}=50V, V_{GS}=10V$ $I_D=30A$ (note 3, 4)	-	30.5	- nC
栅-源电荷 Gate-Source charge	$Q_{gs}$		-	12	- nC
栅-漏电荷 Gate-Drain charge	$Q_{gd}$		-	2.5	- nC
漏-源二极管特性及最大额定值 Drain-Source Diode Characteristics and Maximum Ratings					
正向最大连续电流 Maximum Continuous Drain-Source Diode Forward Current	$I_S$	$T_C=25^\circ\text{C}$	-	-	45 A
正向最大脉冲电流 Maximum Pulsed Drain-Source Diode Forward Current	$I_{SM}$	$T_C=25^\circ\text{C}$	-	-	180 A
正向压降 Drain-Source Diode Forward Voltage	$V_{SD}$	$T_J=25^\circ\text{C}, V_{GS}=0V, I_{SD}=20A$	-	0.9	1.3 V
反向恢复时间 Reverse recovery time	$T_{rr}$	$V_{GS}=0V, I_S=30A$ $dI_F/dt=100A/\mu s$ (note 4)		55	ns
反向恢复电荷 Reverse recovery charge	$Q_{rr}$			95	nc

## 热特性 THERMAL CHARACTERISTIC

项 目 Parameter	符 号 Symbol	最大 Max	单 位 Unit
		MC10N020AL	
结到管壳的热阻 Thermal Resistance, Junction to Case	$R_{th(j-c)}$	1.50	$^\circ\text{C}/\text{W}$
结到环境的热阻 Thermal Resistance, Junction to Ambient	$R_{th(j-A)}$	62.5	$^\circ\text{C}/\text{W}$

注释:

1: 脉冲宽度由最高结温限制

2:  $I_{AS}=20A, V_{DD}=50V, V_{GS}=10V, L=0.3mH, R_G=25\Omega$ , 起始结温  $T_J=25^\circ\text{C}$ 3: 脉冲测试: 脉冲宽度 $\leq 300\mu s$ , 占空比 $\leq 2\%$ 

4: 基本与工作温度无关

Notes:

1: Pulse width limited by maximum junction temperature

2:  $I_{AS}=20A, V_{DD}=50V, V_{GS}=10V, L=0.3mH, R_G=25\Omega$ , Starting  $T_J=25^\circ\text{C}$ 3: Pulse Test: Pulse Width  $\leq 300\mu s$ , Duty Cycle  $\leq 2\%$ 

4: Essentially independent of operating temperature



特征曲线 ELECTRICAL CHARACTERISTICS (curves),  $T_J = 25\text{ }^\circ\text{C}$

On-Region Characteristics

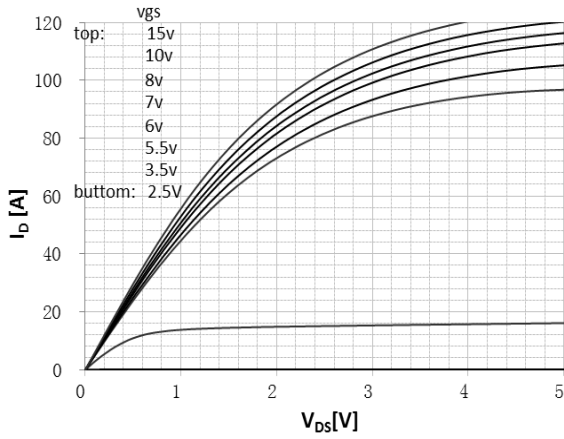

RDSON vs. Tj

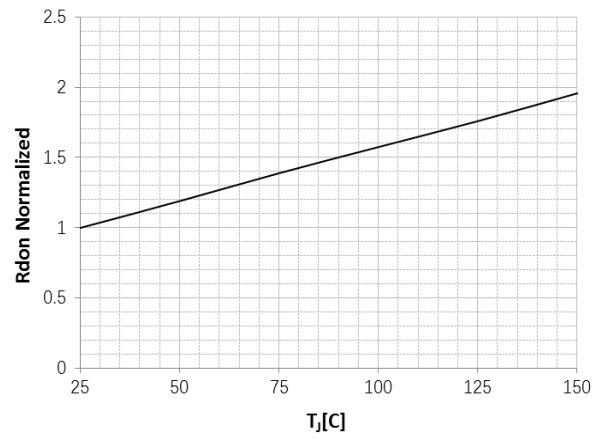

Transfer Characteristics

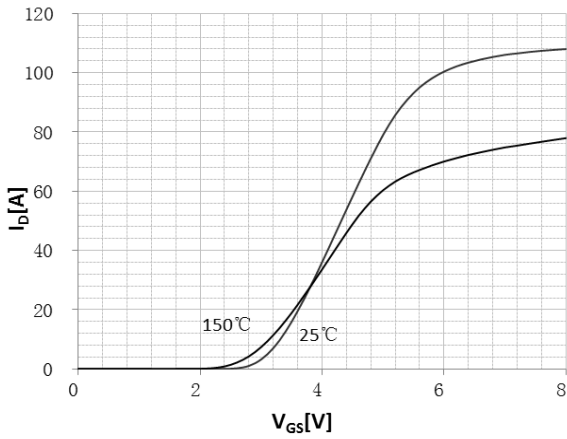

Gate Charge Characteristics

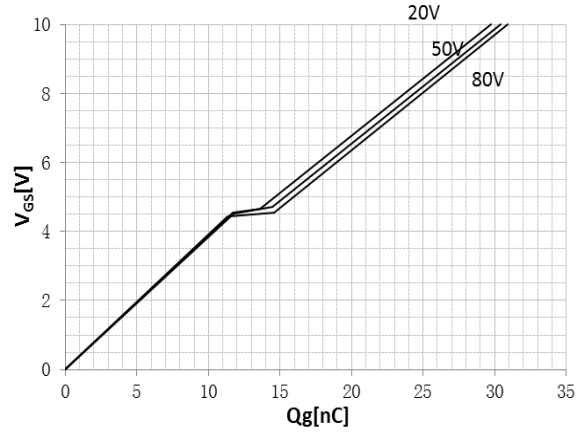

Capacitance Characteristics

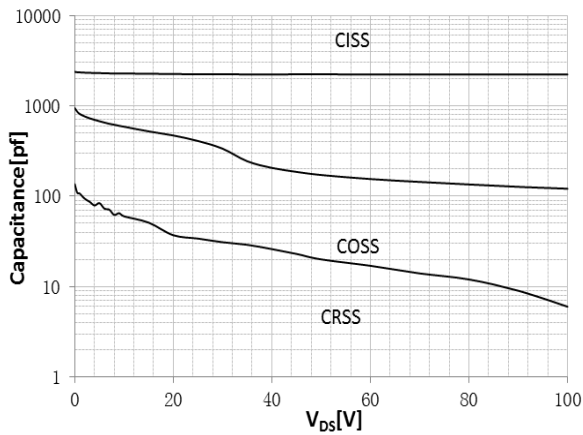

Drain-Source on resistance

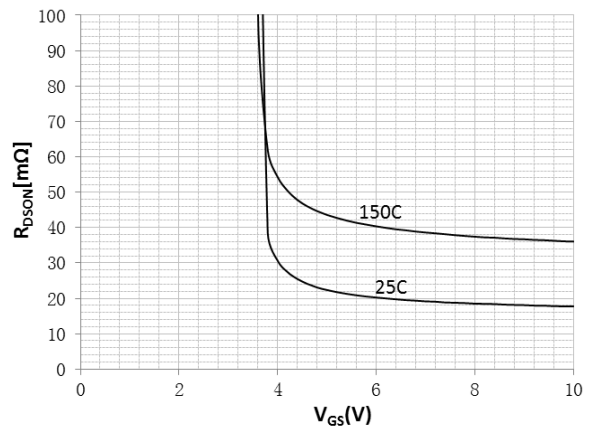



**Body Diode Forward Voltage Variation vs. Source Current and Temperature**

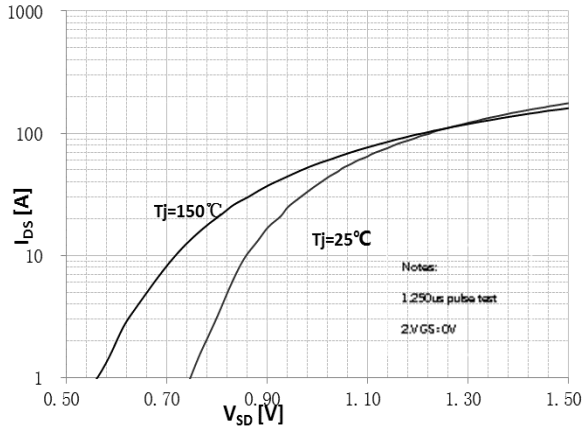

**On-Resistance Variaton vs. Drain Current and Gate Voltage**

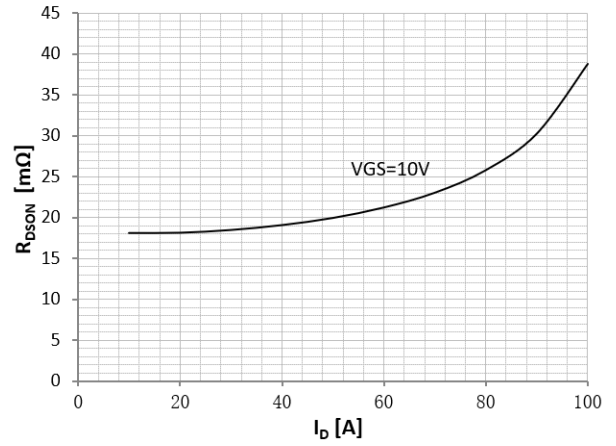

**Drain Current Dissipation vs Tc**

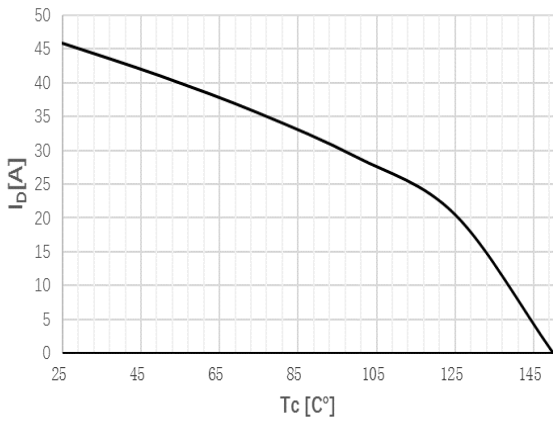

**Transient Thermal Impedance**

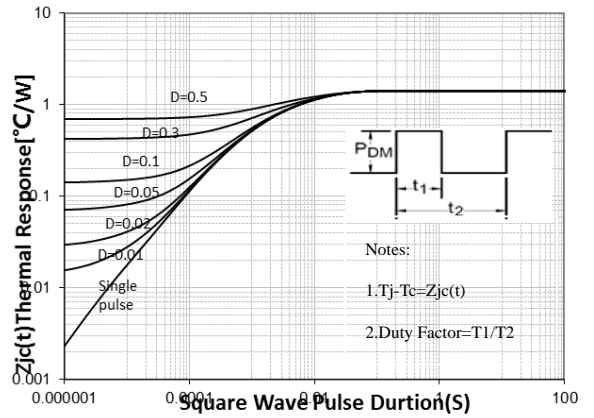

**Gate Threshold Voltage Variation vs Tj**

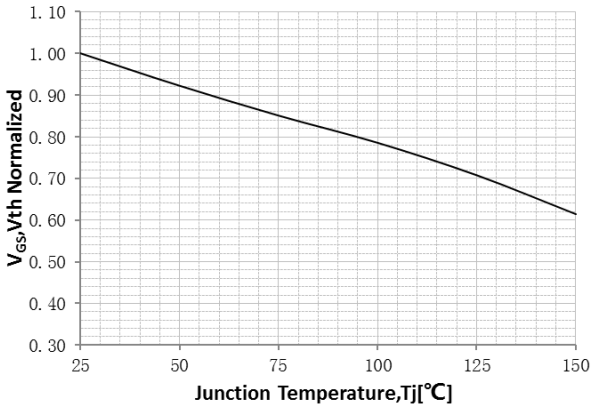

**Breakdown Voltage Variation vs Tj**

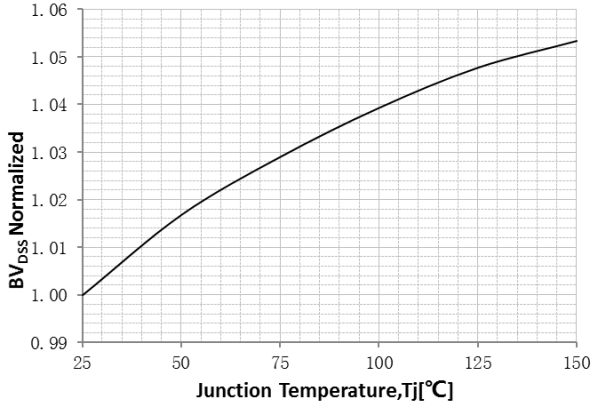



Maximum Safe Operation

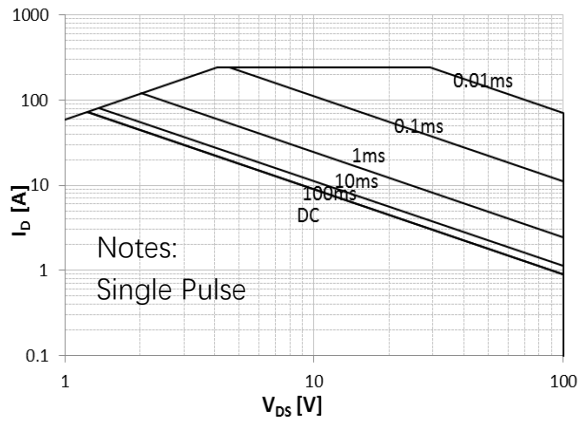

Power Dissipation vs Ta

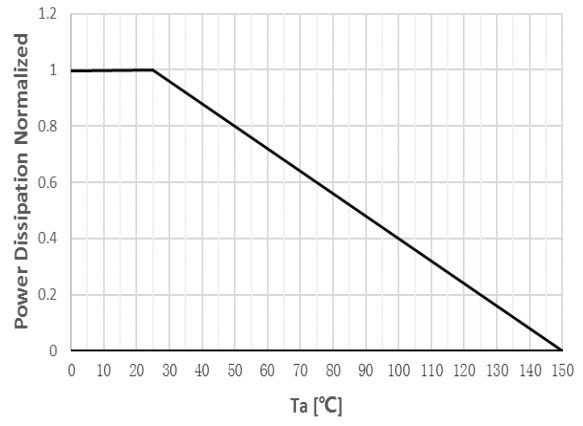

外形尺寸 PACKAGE MECHANICAL DATA

**TO-220C**

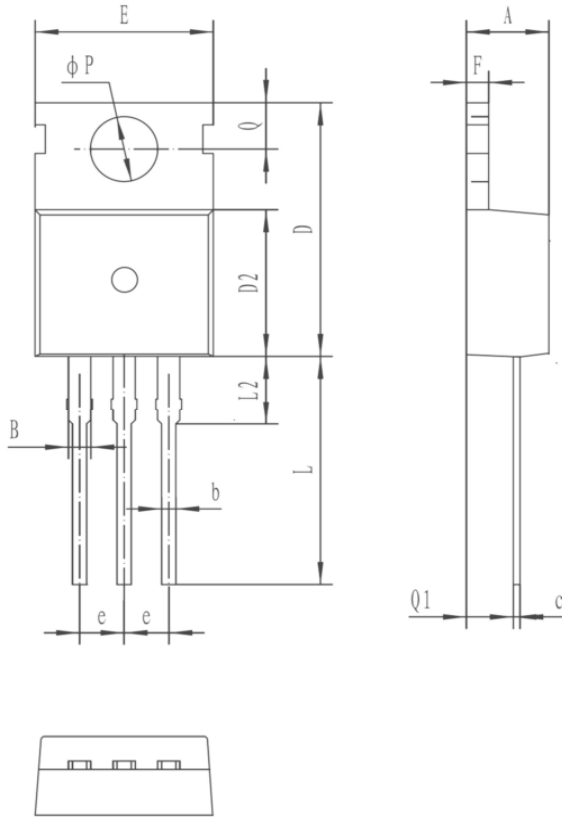

符号 symbol	MIN	MAX
A	4.30	4.70
B	1.10	1.40
b	0.70	0.95
c	0.40	0.65
D	15.20	16.20
D2	9.00	9.40
E	9.70	10.10
e	2.39	2.69
F	1.25	1.40
L	12.60	13.60
L2	2.80	3.20
Q	2.60	3.00
Q1	2.20	2.60
P	3.50	3.80





外形尺寸 PACKAGE MECHANICAL DATA

TO-263

单位 Unit: mm

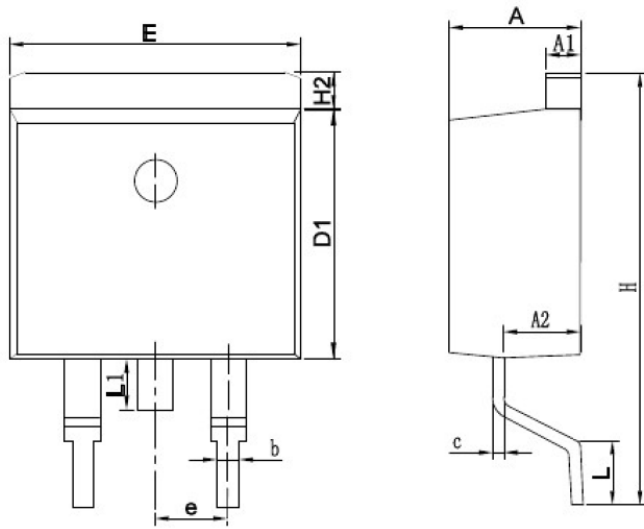

SYMBOL	MM	
	MIN	MAX
A	4.30	4.80
A1	1.12	1.42
A2	2.54	2.84
b	0.67	1.00
c	0.29	0.52
D1	8.40	9.00
E	9.80	10.46
e	2.54BSC	
H	14.00	16.00
H2	1.12	1.45
L	1.50	3.10
L1	1.45	1.70

编带 REEL

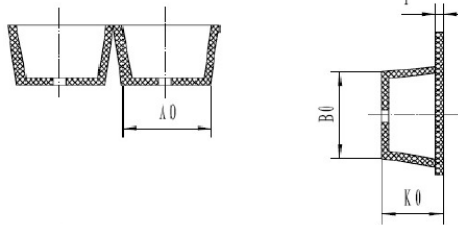
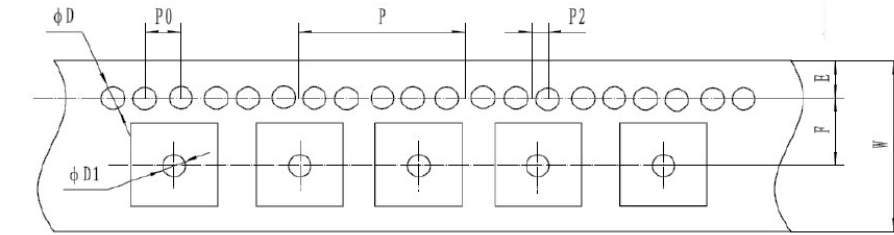

产品尺寸规格 (UNIT: mm)				
规格	W	AO	E	D
尺寸	24 ± 0.3	10.9 ± 0.1	1.75 ± 0.1	1.5 ± 0.1/-0
规格	D1	P0	P	T
尺寸	1.5 ± 0.1/-0	4 ± 0.1	2 ± 0.1	0.35 ± 0.05
规格	K0	BO		
尺寸	4.9 ± 0.1	16.0 ± 0.1		



### 注意事项

1. 吉林华微电子股份有限公司的产品销售分为直销和销售代理，无论哪种方式，订货时请与公司核实。
2. 购买时请认清公司商标，如有疑问请与公司本部联系。
3. 在电路设计时请不要超过器件的绝对最大额定值，否则会影响整机的可靠性。
4. 本说明书如有版本变更不另外告知。

### NOTE

1. Jilin Sino-microelectronics co., Ltd sales its product either through direct sales or sales agent , thus, for customers, when ordering , please check with our company.
2. We strongly recommend customers check carefully on the trademark when buying our product, if there is any question, please don't be hesitate to contact us.
3. Please do not exceed the absolute maximum ratings of the device when circuit designing.
4. Jilin Sino-microelectronics co., Ltd reserves the right to make changes in this. specification sheet and is subject to change without prior notice.

### 联系方式

#### 吉林华微电子股份有限公司

公司地址：吉林省吉林市深圳街 99 号

邮编：132013

总机：86-432-64678411

传真：86-432-64665812

网址：[www.hwdz.com.cn](http://www.hwdz.com.cn)

### CONTACT

#### JILIN SINO-MICROELECTRONICS CO., LTD.

ADD: No.99 Shenzhen Street, Jilin City, Jilin Province, China.

Post Code: 132013

Tel: 86-432-64678411

Fax: 86-432-64665812

Web Site: [www.hwdz.com.cn](http://www.hwdz.com.cn)